

DUCT TYPE AIR CONDITIONER OPERATION MANUAL AND INSTALLATION MANUAL



AD25S2SS1FA
AD35S2SS1FA
AD25S2SS2FA
AD35S2SS2FA



AD50S2SS1FA
AD50S2SS2FA
AD71S2SS1FA
AD71S2SS2FA

Contents

Cautions	3
Safety Precautions	4
Parts and Functions	6
Installation Manual For	
Wire Controller	7
Heating Mode	8
Care and Maintenance	8
Troubleshooting	9
Precaution for Installation	11
Is The Unit Installed Correctly	12
Installation Procedure	13

0150524582

- This product must only be installed or serviced by qualified personnel.
Please read this manual carefully before installation. This appliance is filled with R32.
Keep this manual for future reference.
Original instructions



	Read the precautions in this manual carefully before operating the unit.		This appliance is filled with R32.
	Service indicator; Read technical manual		Read the operator's manual

Keep this manual where the user can easily find it.

WARNING

- Do not use means to accelerate the defrosting process or to clean, other than those recommended by the manufacturer.
- The appliance must be stored in a room without continuously operating ignition sources (for example: open flames, an operating gas appliance or an operating electric heater).
- Do not pierce or burn.
- Be aware that refrigerants may not contain an odour.
- If the supply cord is damaged, it must be replaced by the manufacturer, its service agent or similarly qualified persons in order to avoid a hazard.
- This appliance can be used by children aged 8 years and above and persons with reduced physical, sensory or mental capabilities or lack of experience and knowledge if they have been given supervision or instruction concerning use of the appliance in a safe way and understand the hazards involved. Children shall not play with the appliance. Cleaning and user maintenance shall not be made by children without supervision.
- The wiring method should be in line with the local wiring standard.
- All the cables shall have got the European authentication certificate. During installation, when the connecting cables break off, it must be assured that the grounding wire is the last one to be broken off. The explosion-proof breaker of the air conditioner should be all-pole switch. Distance between its two contacts should not be no less than 3mm. Such means for disconnection must be incorporated in the wiring.
- Make sure installation is done according to local wiring regulation by professional persons.
- Make sure ground connection is correct and reliable.
A leakage explosion-proof breaker must be installed.
- Do not use a refrigerant other than the one indicated on the outdoor unit(R32) when installing, moving or repairing. Using other refrigerants may cause trouble or damage to the unit, and personal injury.
- The installation and service of this product shall be carried out by professional personnel, who have been trained and certified by national training organizations that are accredited to teach the relevant national competency standards that may be set in legislation.
- Mechanical connectors used indoors shall comply with ISO 14903. When mechanical connectors are reused indoors, sealing parts shall be renewed. When flared joints are reused indoors, the flare part shall be re-fabricated.
- This appliance is intended to be used by expert or trained users in shops, in light industry and on farms, or for commercial use by lay persons.
- Disconnect the appliance from its power source during service and when replacing parts

Haier

Haier Industrial Park, No.1 Haier road, Qingdao,P.R.China

EUROPEAN REGULATIONS CONFORMITY FOR THE MODELS

CE

All the products are in conformity with the following European provision:

- Low voltage Directive
- Electromagnetic Compatibility

ROHS

The products are fulfilled with the requirements in the directive 2011/65/EU of the European parliament and of council on the Restriction of the use of Certain Hazardous Substances in Electrical and Electronic Equipment(EU RoHS Directive)

WEEE

In accordance with the directive 2012/19/EU of the European parliament,herewith we inform the consumer about the disposal requirements of the electrical and electronic products.

DISPOSAL REQUIREMENTS:



Your air conditioning product is marked with this symbol.This means that electrical and electronic products shall not be mixed with unsorted household waste.Do not try to dismantle the system yourself:the dismantling of the air

conditioning system,treatment of the refrigerant,of oil and of other part must be done by a qualified installer in accordance with relevant local and national legislation.Air conditioners must be treated at a specialized treatment facility for reuse, recycling and recovery.By ensuring this product is disposed of correctly,you will help to prevent potential negative consequences for the environment and humen health.Please contact the installer or local authority for more information. Battery must be removed from the remote controller and disposed of separately in accordance with relevant local and nationl legislation.

IMPORTANT INFORMATION REGARDING THE REFRIGERANT USED

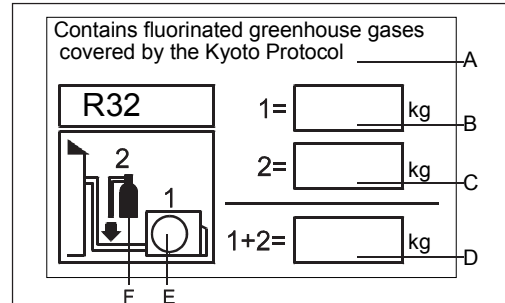

This product contains fluorinated greenhouse gases covered by the Kyoto Protocol.Do not vent into the atmosphere.

Refrigerant type:R32

GWP:675

GWP=global warming potential

Please fill in with indelible ink,

- 1 the factory refrigerant charge of the product
- 2 the additional refrigerant amount charged in the field and
- 1+2 the total refrigerant charge

on the refrigerant charge label supplied with the product. The filled out label must be adhered in the proximity of the product charging port(e.g.onto the inside of the stop value cover).

A contains fluorinated greenhouse gases covered by the Kyoto Protocol

B factory refrigerant charge of the product:see unit name plate

C additional refrigerant amount charged in the field

D total refrigerant charge

E outdoor unit

F refrigerant cylinder and manifold for charging

⚠ WARNING

If the supply cord is damaged, it must be replaced by the manufacturer, its service agent or similarly qualified persons in order to avoid a hazard.

This appliance is not intended for use by persons (including children) with reduced physical, sensory or mental capabilities, or lack of experience and knowledge, unless they have been given supervision or instruction concerning use of the appliance by a person responsible for their safety.

Children should be supervised to ensure that they do not play with the appliance.

This appliance can be used by children aged from 8 years and above and persons with reduced physical, sensory or mental capabilities or lack of experience and knowledge if they have been given supervision or instruction concerning use of the appliance in a safe way and understand the hazards involved. Children shall not play with the appliance. Cleaning and user maintenance shall not be made by children without supervision.

The appliances are not intended to be operated by means of an external timer or separate remote-control system.

Keep the appliance and its cord out of reach of children less than 8 years.

Cautions

Disposal of the old air conditioner

Before disposing an old air conditioner that goes out of use, please make sure it's inoperative and safe. Unplug the air conditioner in order to avoid the risk of child entrapment.

It must be noticed that air conditioner system contains refrigerants, which require specialized waste disposal. The valuable materials contained in an air conditioner can be recycled. Contact your local waste disposal center for proper disposal of an old air conditioner and contact your local authority or your dealer if you have any question. Please ensure that the pipework of your air conditioner does not get damaged prior to being picked up by the relevant waste disposal center, and contribute to environmental awareness by insisting on an appropriate, anti-pollution method of disposal.

Disposal of the packaging of your new air conditioner

All the packaging materials employed in the package of your new air conditioner may be disposed without any danger to the environment.

The cardboard box may be broken or cut into smaller pieces and given to a waste paper disposal service. The wrapping bag made of polyethylene and the polyethylene foam pads contain no fluorochloric hydrocarbon.

All these valuable materials may be taken to a waste collecting center and used again after adequate recycling.

Consult your local authorities for the name and address of the waste materials collecting centers and waste paper disposal services nearest to your house.

Safety Instructions and Warnings

Before starting the air conditioner, read the information given in the User's Guide carefully. The User's Guide contains very important observations relating to the assembly, operation and maintenance of the air conditioner.

The manufacturer does not accept responsibility for any damages that may arise due to non-observation of the following instruction.

- Damaged air conditioners are not to be put into operation. In case of doubt, consult your supplier.
- Use of the air conditioner is to be carried out in strict compliance with the relative instructions set forth in the User's Guide.
- Installation shall be done by professional people, don't install unit by yourself.
- For the purpose of safety, the air conditioner must be properly grounded in accordance with specifications.
- Always remember to unplug the air conditioner before opening inlet grill. Never unplug your air conditioner by pulling on the power cord. Always grip plug firmly and pull straight out from the outlet.
- All electrical repairs must be carried out by qualified electricians. Inadequate repairs may result in a major source of danger for the user of the air conditioner.
- Do not damage any parts of the air conditioner that carry refrigerant by piercing or perforating the air conditioner's tubes with sharp or pointed items, crushing or twisting any tubes, or scraping the coatings off the surfaces. If the refrigerant spurts out and gets into eyes, it may result in serious eye injuries.
- Do not obstruct or cover the ventilation grille of the air conditioner. Do not put fingers or any other things into the inlet/outlet and swing louver.
- Do not allow children to play with the air conditioner. In no case should children be allowed to sit on the outdoor unit.















Safety Precautions

- Before starting to use the system, read carefully this "SAFETY PRECAUTIONS" to ensure a proper operation of the system.
- Safety precautions described here are classified to " ⚠ **WARNING**" and " ⚠ **CAUTION**". Precautions which are shown in the column of " ⚠ **WARNING**" means that an improper handling could lead to a grave result like a death, serious injury, etc. However, even if precautions are shown in the column of " ⚠ **CAUTION**", a very serious problem could occur depending on situation. Make sure to observe these safety precautions faithfully because they are very important information to ensure the safety.
- Symbols which appear frequently in the text have following meanings.



	Strictly prohibited.		Observe instructions faithfully.		Provide a positive grounding.
---	----------------------	---	----------------------------------	---	-------------------------------

- When you have read through the manual, keep it always at hand for read consultation. If the operator is replaced, make sure to hand over this manual to the new operator.

CAUTIONS FOR INSTALLATION

 WARNING		
<p>The system should be applied to places as office, restaurant, residence and the like.</p> <p></p> <p>Application to inferior environment such as an engineering shop, could cause equipment malfunction and serious injury or death.</p>	<p>The system should be installed by your dealer or a professional installer.</p> <p></p> <p>Installation by yourself is not encouraged because it could cause such problems as water leakage, electrical shock or fire accident by some improper handling.</p>	<p>When you need some optional devices such as a humidifier, electric heater, etc., be sure to use the products which are recommended by us. These devices should be attached by a professional installer.</p> <p></p> <p>Installation by yourself is not encouraged because it could cause such problems as water leakage, electrical shock or fire accident by some improper handling.</p>
 CAUTION		
<p>Do not install nearby the place where may have leakage of flammable gas.</p> <p></p> <p>If the gas leaks and gathers around, it may cause the fire.</p> 	<p>Depending on the place of installation, a circuit breaker may be necessary.</p> <p></p> <p>Unless the circuit breaker is installed, it could cause electrical shocks.</p> 	<p>Drain pipe should be arranged to provide a positive draining.</p> <p></p> <p>If the pipe is arranged improperly, furniture or the likes may be damaged by leaked water.</p> 
<p>Where strong winds may prevail, the system should be fixed securely to prevent a collapse.</p> <p></p> <p>Bodily injury could result by a collapse.</p>	<p>Install on the place where can endure the weight of air conditioner.</p> <p></p> <p>Bodily injury could result by a careless installation.</p>	<p>Make sure the system is grounded.</p> <p></p> <p>Grounding cable should never be connected to a gas pipe, city water pipe, lightning conductor rod or grounding cable of telephone. If the grounding cable is not set properly, it could cause electric shocks.</p> 

CAUTIONS FOR TRANSFER OR REPAIR

 WARNING	
<p>Modification of the system is strictly prohibited. When the system needs a repair, consult your dealer.</p> <p></p> <p>Improper practice of repair could cause water leakage, electric shock or fire.</p>	<p>When the air conditioner is relocated, contact your dealer or a professional installer.</p> <p></p> <p>Improper practice of installation could cause water leakage, electric shock or fire.</p>

Safety Precautions

CAUTIONS FOR OPERATION

⚠ WARNING

You should refrain from exposing your body directly to cool wind for a long time.



It could affect your physical condition or cause some health problems.

Do not poke the air inlet or outlet with a bar, etc.



Since the internal fan is operating with a high speed, it could cause an injury.

When any abnormal condition (scorching smell or others) is found, stop the operation immediately and turn off the power switch. Then consult your dealer.



If you continue the operation without removing the cause, it could result in a trouble, electric shock or fire.

⚠ CAUTION

The system should never be used for any other purposes than intended such as for preservation of food, flora and fauna, precision devices or work of art.

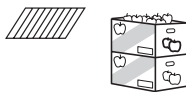

It could cause deterioration of food or other problems.

Do not handle switches with a wet hand.



It could cause electric shocks.

Combustion apparatus should not be placed allowing a direct exposure to wind of air conditioner.

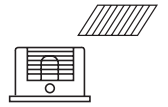

Incomplete combustion could occur on the apparatus.

Do not wash the air conditioner with water.

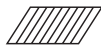

It could cause electric shocks.

Do not install the system where the air outlet reaches directly the flora and fauna.

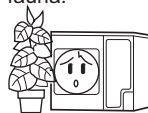

It will not be good for their health.

Make sure to use a fuse of proper electric rating.



Use of steel or copper wire in place of a fuse is strictly prohibited because it could result in a trouble or fire accident.

Neither stand on the air conditioner nor place something on it.



There are risks of falling or injury by collapsed object.

It is strictly prohibited to place a container of combustible gas or liquid near the air conditioner or to spray it directly with the gas or liquid.



It could cause a fire accident.

Do not operate the system while the air outlet grill is removed.



There is a risk of injury.

Do not use the power switch to turn on or off the system.

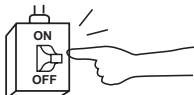

It could cause a fire or water leakage.

Do not touch the air outlet section while the swing louver is operating.



There is a risk of injury.

Do not use such equipment as a water heater, etc. around the indoor unit or the wire controller.



If the system is operated at the vicinity of such equipment which generates steam, condensed water may drip during cooling operation or it could cause a fault current or short-circuit.

When operating the system simultaneously with a combustion apparatus, indoor air must be ventilated frequently.



Insufficient ventilation could cause an oxygen deficiency accident.

Check occasionally the support structure of the unit for any damage after a use of long period of time.



If the structure is not repaired immediately, the unit could topple down to cause a personal injury.

When cleaning the system, stop the operation and turn off the power switch.



Cleaning should never be done while the internal fans are running with high speed.

Do not put water containers on the unit such as a flower vase, etc.



If the water enters into the unit and damages the electric insulation material, it may cause electric shock.

Safety Precautions

The machine is adaptive in following situation

1. Applicable ambient temperature range:

Cooling	Indoor temperature	max.	DB/WB	32/23°C
		min.	DB/WB	18/14°C
	Outdoor temperature	max.	DB/WB	46/24°C
		min.	DB/WB	18°C
Heating	Indoor temperature	max.	DB/WB	27°C
		min.	DB/WB	15°C
	Outdoor temperature	max.	DB/WB	24/18°C
		min.	DB/WB	-15°C

2. If the supply cord is damaged, it must be replaced by the manufacturer or its service agent or a similar qualified person.
3. If the fuse on PC board is broken please change it with the type of T 3.15A /250VAC.
4. The wiring method should be in line with the local wiring standard.
5. The breaker of the air conditioner should be all-pole switch, and the distance between its two contacts should be no less than 3mm. Such means for disconnection must be incorporation in the fixed wiring.
6. The installation height of the indoor unit is recommended from 2.5m to 2.7m.
7. The distance between its two terminal blocks of indoor unit and outdoor unit should not be over 5m. If exceeded, the diameter of the wire should be enlarged according to the local wiring standard.
8. The waste battery shall be disposed properly.
9. we can get the 4 different ESP through adjust the indoor unit PCB SW1-4 and SW1-5, please refer below:

SW01								Static pressure
[1]	[2]	[3]	[4]	[5]	[6]	[7]	[8]	
--	--	--	0	0	--	--	--	0Pa
--	--	--	0	1	--	--	--	10Pa
--	--	--	1	0	--	--	--	20Pa
--	--	--	1	1	--	--	--	30Pa

Attention: cut off the power supply to adjust the SW1-4, and SW1-5, or else the operation is invalid.

Parts and Functions

AD25S2SS1FA
 AD35S2SS1FA
 AD50S2SS1FA
 AD71S2SS1FA
 AD25S2SS2FA
 AD35S2SS2FA
 AD50S2SS2FA
 AD71S2SS2FA

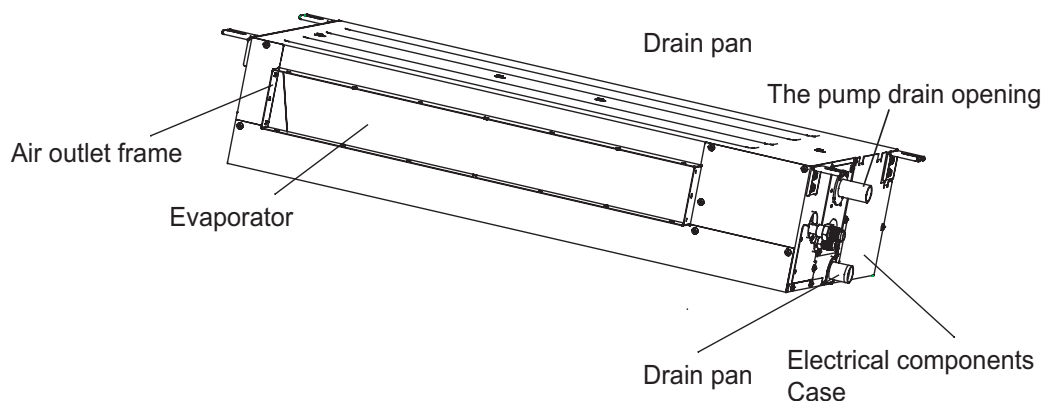

Installation Manual For Wire Controller

5. Wiring connections of wire controller:

There are three methods to connection wire controller and the indoor units:

- A. One wired controller can control max. up to 6 sets of indoor units, and 3 pieces of polar wire must connect the wire controller and the master unit (the indoor unit connected with wire controller directly), the others connect with the master unit through pieces of polar wire.
- B. One wire controller controls one indoor unit, and the indoor unit connects with the wire controller through 3 pieces of polar wire.
- C. Two wired controllers control one indoor unit. The wire controller connected with indoor unit is called master one, the other is called slave one. Master wire controller and indoor unit; master and slave wire controllers are all connected through 3 pieces of polar wire.

6. Communication wiring:

The wire controller is equipped with special communication wiring in the accessories. 3-core terminal (white-yellow 3-red) is connected with the terminal A, B, C of wire controller respectively. The communication wiring is 5 meter long; if the actual length is more than it, please distribute wiring according to below table:

Communication wiring length(m)	Dimensions of wiring
< 100	0.3mm ² x3-core shielded wire
≥100 and <200	0.5mm ² x3-core shielded wire
≥200 and <300	0.75mm ² x3-core shielded wire
≥300 and <400	1.25mm ² x3-core shielded wire
≥400 and <600	2mm ² x3-core shielded wire

*One side of the shielded sheet of communication wire must be earthed.

Heating Mode

"HOT KEEP" function

"HOT KEEP" is operated in the following cases.

- When heating is started:
In order to prevent blowing out of cool wind, the indoor unit fan stopped according to the room temperature which heating operation is started. Wait for approx. 2 to 3 minute, and the operation will be automatically changed to the ordinary heating mode.
- Defrosting operation (in the heating mode):
When it is liable to frost, the heating operation is stopped automatically for 5 to 12 minutes once per approx. one hour, and defrosting is operated. After defrosting is completed, operation mode is automatically changed to ordinary heating operation.
- When the room thermostat is actuated:
When room temperature increases and room temperature controller actuates, the fan speed is automatically changed to stop under low temperature condition of indoor heat exchanger. When room temperature decreases, air conditioner automatically changes over to ordinary heating operation.



Warming operation

- Heat pump type warming
With the heat pump type warming, the mechanism of heat pump that concentrate heat of outdoor air with the help of refrigerant to warm the indoor space, is utilized.
- Defrosting operation
- When a room is warmed with a heat pump type air conditioner, frost accumulates on the heat exchanger of outdoor unit along with the drop of indoor temperature. Since the accumulated frost reduces the effect of warming, it is necessary to automatically switch the operation to the defrosting mode. During the defrosting operation, heating operation is interrupted.
- Atmospheric temperature and warming capacity
Warming capacity of heat pump type air conditioner decreases along with the drop of outdoor temperature. When the warming capacity is not sufficient, it is recommended to use another heating implement.
- Period of warm-up
Since the heat pump type air conditioner employs a method to circulate warm winds to warm the entire space of a room, it takes time before the room temperature rises. It is recommendable to start the operation a little earlier in a very cold morning.

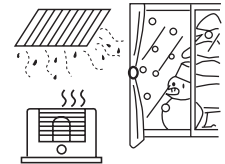

Care and Maintenance

Points to observe

Turn off the power supply switch. 	Do not touch with wet hand. 	Do not use hot water or volatile liquid. 
--	--	---

⚠ CAUTION

- Do not open the inlet grill until fan stops completely.
- Fan will continue rotating for a while by the law of inertia after operation is being stopped.

Cleaning the air filter

1. Clean the air filter by lightly tapping it or with the cleaner. It is more effective to clean the air filter with water.

If the air filter is very dirty, dissolve neutral detergent in the lukewarm water (approx. 30 °C), rinse the air filter in the water, and thoroughly wash off the detergent on the air filter in the plain water.

2. After drying the air filter, set it up on the air conditioner.



⚠ CAUTION

- Do not dry the air filter with fire.
- Do not run the air conditioner without the air filter.

Care and Cleaning of the unit

- Clean with soft and dry cloth.
- If it is very dirty, dissolve neutral detergent in the lukewarm water and make the cloth wet with the water. After wiping, clean off the detergent using clean water.

Post-Season Care



- Operate the unit with FAN mode on a fair day for about half a day to dry the inside of the unit well.
- Stop operation and turn off the power supply switch. Electric power is consumed even if the air conditioner is in stop.
- Clean the air filter and set it in the place.

Pre-Season Care

- See that there are no obstacles blocking the air inlet and air outlet of both indoor and outdoor units.
- Make sure that the air filter is not dirty.
- Turn on the power supply switch 12 hours before starting run.

Troubleshooting



Please check the following things about your air conditioner before making a service call.

Unit fails to start			
<p>Is the power source switch adjust cut in?</p>  <p>Power supply switch is not ON.</p>	<p>Is city supply power in normal?</p> 	<p>Isn't the signal receiving section exposed to the direct sunlight or strong illumination?</p>	<p>Isn't the earth leakage breaker in action?</p> <p>It is dangerous. Turn off the power supply switch immediately and contact the sales dealer.</p>
Cooling or heating is not sufficient			
<p>Is the thermostat adjusted as required?</p>	<p>Isn't the air filter dirty?</p>	<p>Isn't any doors or windows left open?</p>	<p>Doesn't any obstacle exist at the air inlet or outlet?</p>
Cooling is not sufficient			
<p>Isn't sun-shine invading direct?</p>	<p>Isn't any unexpected heating load generated?</p>	<p>Isn't the room much crowded?</p>	<p>The wind does not blow during heating operation. Isn't it warming up?</p>

When the air conditioner does not operate properly after you have checked the above mentioned items or when the following phenomenon is observed, stop the operation of the air conditioner and contact your sales dealer.

- The fuse or breaker often shuts down.
- Water drops off during cooling operation.
- There is an irregularity in operation or abnormal sound is audible.

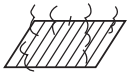
The followings are not malfunction

<p>Water flowing sound is heard.</p> 	<p>When the air conditioner is started, when the compressor starts or stops during operation or when the air conditioner is stopped, it sometimes sounds "shuru shuru" or "gobo gobo". It is the flowing sound of the refrigerant, and it is not a trouble.</p>
<p>Cracking sound is heard.</p>	<p>This is caused by heat expansion or contraction of plastics.</p>
<p>It smells.</p>	<p>Air which blows out from the indoor unit sometimes smells. The smell results from residents of tobacco smoke or cosmetics stuck inside of unit.</p>
<p>During operation, white fog comes out of indoor unit.</p>	<p>When the air conditioner is used at restaurant etc. where dense edible oil fume is always exists, white fog sometimes blows out of air outlet during operation. In this case consult sales dealer for cleaning the heat exchanger.</p>
<p>It is switched into the FAN mode during cooling.</p> 	<p>To prevent frost from being accumulated on the indoor unit heat exchanger, it is sometimes automatically switched to the FAN mode but it will soon return to the cooling mode.</p>
<p>The air conditioner can not be restarted soon after it stops.</p>	<p>Even if the operation switch is turned on, cooling, dehumidifying or heating is not operable for three minutes after the conditioner is stopped. Because the protecting circuit is activated. (During this time air conditioner operates in fan mode.)</p>
<p>Air does not blow or the fan speed can not be changed during dehumidifying</p> 	<p>When it is excessively cooled during dehumidifying, the blower automatically repeats reducing and lowering the fan speed.</p> 
<p>During operation, operation mode has changed over automatically.</p>	<p>Isn't the AUTO mode selected? In the case of AUTO mode, operation mode is changed automatically from cooling to heating or vise-versa according to the room temperature.</p>
<p>Water or steam generates from the outdoor unit during heating.</p>	<p>This results when frost accumulated on the outdoor unit is removed (during defrosting operation).</p>

Troubleshooting

When failure happens, the fan of indoor unit stop running. The method of check failure code see page 12.

For outdoor failure, the failure code is outdoor failure LED flash times + 20.

For example, the failure code of outdoor unit is 2. the wired controller of indoor unit will display 16 (using hexadecimal method).

Ta: ambient temperature sensor
Tm: coil temperature sensor

Failure code(from receive board)		Failure code(from wired controller)	Failure code(from panel controller)	Trouble shooting	Possible reasons
Flash times of Timing LED(or indoor PCB LED4)	Flash times of Running LED(or indoor PCB LED3)				
0	1	01	E1	Temperature sensor Ta faulty	Sensor disconnected , or broken , or at wrong position , or short circuit
0	2	02	E2	Temperature sensor Te faulty	Sensor disconnected , or broken , or at wrong position , or short circuit
0	4	04	F8	EEPROM wrong	Faulty indoor unit PCB
0	7	07	E9	Abnormal communication between indoor and outdoor units	Wrong connection , or the wires be disconnected , or wrong address setting of indoor unit , or faulty power supply or faulty PCB
0	8	No error code display	E8	Abnormal communication between indoor wired controller and indoor unit PCB	Abnormal communication between indoor wired controller and indoor unit PCB
0	12	0C	E0	Drainage system abnormal	Pump motor disconnected , or at wrong position , or the float switch broken down , or the float switch disconnected , or at wrong position.
0	13	0D	EF	Zero cross sigal wrong	Zero cross sigal detected wrong,or wired controller short circuit
0	14	0E	/	Indoor unit DC Fan motor abnormal	DC Fan motor disconnected , or DC Fan broken , or circuit broken
0	16	10	F3	Indoor mode abnormal	Different from outdoor unit mode
2	1	15	/	Outdoor unit abnormal	Refer to the outdoor unit trouble shooting list
2	2	16	/	Outdoor unit abnormal	
2	4	18	/	Outdoor unit abnormal	
2	5	19	/	Outdoor unit abnormal	
2	7	1B	/	Outdoor unit abnormal	
2	8	1C	/	Outdoor unit abnormal	
2	9	1D	/	Outdoor unit abnormal	
3	0	1E	/	Outdoor unit abnormal	
3	1	1F	/	Outdoor unit abnormal	
3	2	20	/	Outdoor unit abnormal	
3	3	21	/	Outdoor unit abnormal	
3	5	23	/	Outdoor unit abnormal	
3	6	24	/	Outdoor unit abnormal	
3	7	25	/	Outdoor unit abnormal	
3	8	26	/	Outdoor unit abnormal	
3	9	27	/	Outdoor unit abnormal	
4	3	2B	/	Outdoor unit abnormal	
4	4	2C	/	Outdoor unit abnormal	
4	7	2F	/	Outdoor unit abnormal	
4	8	30	/	Outdoor unit abnormal	
4	9	31	/	Outdoor unit abnormal	
5	8	3A	/	Outdoor unit abnormal	
5	9	3B	/	Outdoor unit abnormal	
6	3	3F	/	Outdoor unit abnormal	
6	4	40	/	Outdoor unit abnormal	

1.For the indoor failure , only running LED on remote receiver (or indoor PCB LED3) will indicate.

2.To get much more details of outdoor unit failure , please refer to the outdoor unit trouble shooting list.

Precaution for Installation

- Please read these "Safety Precautions" first and then accurately execute the installation work.
- Though the precautionary points indicated herein are divided under two headings, **⚠ WARNING** and **⚠ CAUTION**, those points which are related to the strong possibility of an installation done in error resulting in death or serious injury are listed in the **⚠ WARNING** section. However, there is also a possibility of serious consequences in relationship to the points listed in the **⚠ CAUTION** section as well. In either case, important safety related information is indicated, so by all means, properly observe all that is mentioned.
- After completing the installation, along with confirming that no abnormalities were seen from the operation tests, please explain operating methods as well as maintenance methods to the user (customer) of this equipment, based on the owner's manual. Moreover, ask the customer to keep this sheet together with the owner's manual.

⚠ WARNING

- This system should be applied to places as office, restaurant, residence and the like. Application to inferior environment such as engineering shop could cause equipment malfunction.
- Please entrust installation to either the company which sold you the equipment or to a professional contractor. Defects from improper installations can be the cause of water leakage, electric shocks and fires.
- Execute the installation accurately, based on following the installation manual. Again, improper installations can result in water leakage, electric shocks and fires.
- When a large air-conditioning system is installed to a small room, it is necessary to have a prior planned countermeasure for the rare case of a refrigerant leakage, to prevent the exceeding of threshold concentration. In regards to preparing this countermeasure, consult with the company from which you purchased the equipment, and make the installation accordingly. In the rare event that a refrigerant leakage and exceeding of threshold concentration does occur, there is the danger of a resultant oxygen deficiency accident.
- For installation, confirm that the installation site can sufficiently support heavy weight. When strength is insufficient, injury can result from a falling of the unit.
- Execute the prescribed installation construction to prepare for earthquakes and the strong winds of typhoons and hurricanes, etc. Improper installations can result in accidents due to a violent falling over of the unit.
- For electrical work, please see that a licensed electrician executes the work while following the safety standards related to electrical equipment, and local regulations as well as the installation instructions, and that only exclusive use circuits are used. Insufficient power source circuit capacity and defective installation execution can be the cause of electric shocks and fires.
- Accurately connect wiring using the proper cable, and insure that the external force of the cable is not conducted to the terminal connection part, through properly securing it. Improper connection or securing can result in heat generation or fire.
- Take care that wiring does not rise upward, and accurately install the lid/service panel. Its improper installation can also result in heat generation or fire.
- When setting up or moving the location of the air conditioner, do not mix air etc. or anything other than the designated refrigerant within the refrigeration cycle. Rupture and injury caused by abnormal high pressure can result from such mixing.
- Always use accessory parts and authorized parts for installation construction. Using parts not authorized by this company can result in water leakage, electric shock, fire and refrigerant leakage.



⚠ CAUTION

- Execute proper grounding. Do not connect the ground wire to a gas pipe, water pipe, lightning rod or a telephone ground wire. Improper placement of ground wires can result in electric shock.
- The installation of an earth leakage breaker is necessary depending on the established location of the unit. Not installing an earth leakage breaker may result in electric shock.
- Do not install the unit where there is a concern about leakage of combustible gas. The rare event of leaked gas collecting around the unit could result in an outbreak of fire.
- For the drain pipe, follow the installation manual to insure that it allows proper drainage and thermally insulate it to prevent condensation. Inadequate plumbing can result in water leakage and water damage to interior items.

Is The Unit Installed Correctly

Confirm the following items for safe and comfortable use of air conditioner.

The installation work is to be burden on the sales dealer, and do not conduct it by yourself.

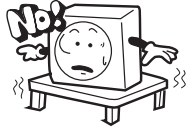
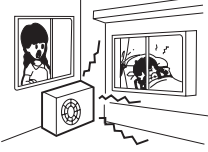
Installation place		
<p>Avoid installing the air conditioner near the place where possibility of inflammable gas leakage exists.</p>  <p>Explosion (Ignition) may occur.</p>	<p>Install the unit at well ventilated place.</p>  <p>If some obstacle exist, it may cause capacity reduction or noise increase.</p>	<p>Install the air conditioner firmly on the foundation that can fully support the weight of the unit.</p>  <p>If not, it may cause vibration or noise.</p>
<p>Select the place so as not to annoy neighbor with the hot air or noise.</p> 	<p>Snow protection work is necessary where outdoor unit is blocked up by snow.</p> <p>For details consult your sales dealer.</p> <ul style="list-style-type: none"> • The place where corrosive gas generates (Hot spring area etc.) • The place where salt breeze blows (Seaside etc.) • The place where dense soot smoke exists • The place where humidity is extraordinarily high • The place where near the machine which radiates the electromagnetic wave • The place where voltage variation is considerably large 	<p>It is advisable not to install the air conditioner at the following special place. It may cause malfunction, consult the sales dealer when you have to install the unit on such a place.</p>

Electric work

The electric work must be burden on the authorized engineer with qualification for electric work and grounding work, and the work must be conducted in accordance with electric equipment technical standard.

- The power source for the unit is to be of exclusive use.
- An earth leakage breaker should be installed. This is necessary to prevent electric shock.
- The unit must be grounded.

When you change your address or the installation place

Special technology is required for removal or reinstallation of air conditioner, consult the sales dealer. Besides, construction expense is charged for removal or reinstallation.

For inspection and maintenance

The capacity of air conditioner will decrease by contamination of inside of unit when it is used for about three years although depending upon the circumstances under which it is used, and so in addition to the usual maintenance service, special inspection/maintenance service is necessary. It is recommended to make a maintenance contract (charged) by consulting your sales dealer.

In the place with much dust, the condenser is easy to be blocked, which will result in the low cooling efficiency. So please clean in period.

Installation Procedure

Indoor Unit

⚠ CAUTION

Please do not install the unit in places where flammable gases may be leaked. In case that gas is leaked and accumulated around the unit, it may cause dangers of fire etc.

The indoor unit shall be installed at locations where cold and hot air could evenly circulated. The following locations should be avoided

- Places with rich saline matters (seaside regions).
- Places with plenty of gas sulfides (mainly in warm spring areas where the copper tube and braze weld is prone to corrosion).
- Locations with much oil (including mechanical oil) and steam.
- Locations using organic solvents.
- Places where there are machines generating HF electromagnetic waves.
- Positions adjacent to door or window in contact with high-humidity external air. (Easy to generate dew).
- Locations frequently using special aerosols.

Selecting the mounting position to install the indoor units

- Select suitable places where the outlet air can be sent to the entire room, and convenient to lay out the connection pipe, connection wire and the drainage pipe to outdoor.
- The ceiling structure must be strong enough to support the unit weight.
- The connecting pipe, drain pipe and connection wire shall be able to go through the building wall to connect between the indoor and outdoor units.
- The connecting pipe between the indoor and outdoor units as well as the drain pipe shall be as short as possible.
- If it is necessary to adjust the filling amount of the refrigerant, please refer to the installation manual attached with the outdoor unit.
- The connecting flange should be provided by the user himself.
- The indoor unit has two water outlets one of which is obstructed at the factory (with a rubber cap). Only the outlet not obstructed (liquid inlet and outlet side) will be generally used during installation. If applicable, both the outlets should be used together.
- An access port must be provided during installation of indoor unit for maintenance.

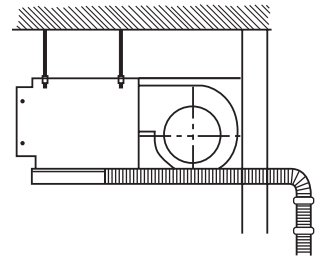

After selecting the unit installation location, proceed the following steps:

1. Drill a hole in the wall and insert the connecting pipe and wire through a PVC wall-through tube purchased locally. The wall hole shall be with a outward down slope of at least 1/100.
2. Before drilling check that there is no pipe or reinforcing bar just behind the drilling position. Drilling shall avoid at positions with electric wire or pipe.
3. Mount the unit on a strong and horizontal building roof. If the base is not firm, it will cause noise, vibration or leakage.
4. Support the unit firmly.
5. Change the form of the connection pipe, connection wire and drain pipe so that they can go through the wall hole easily.

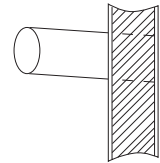

Installation dimension

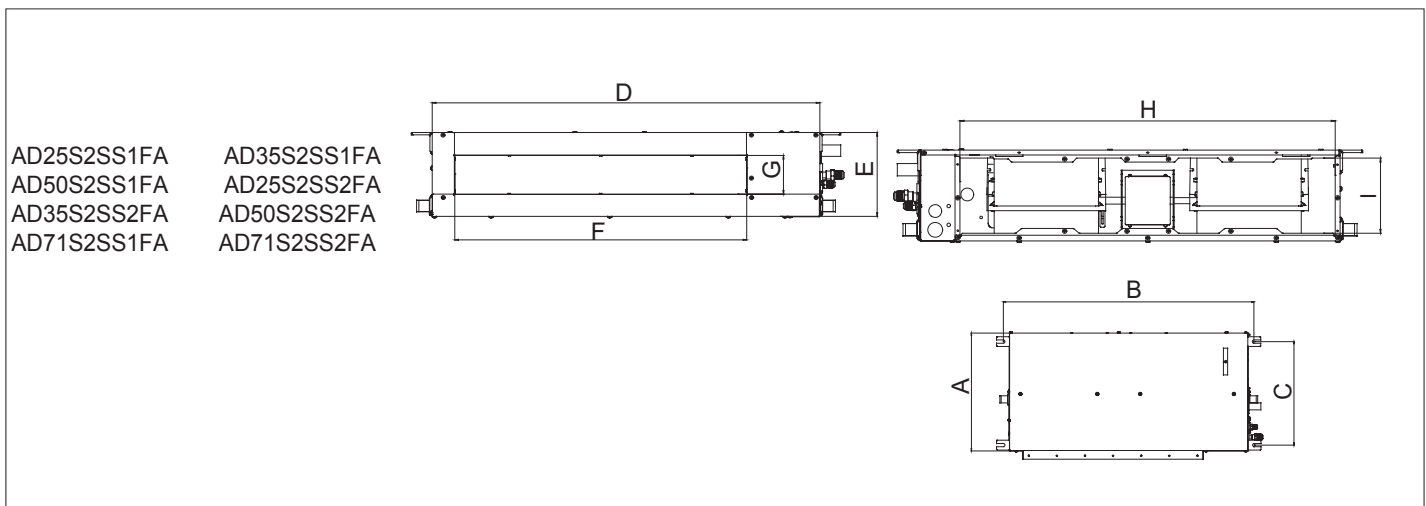

Indoor unit dimensions(unit:mm)

Unit model	A	B	C	D	E	F	G	H	I
AD25S2SS1FA AD35S2SS1FA AD25S2SS2FA AD35S2SS2FA	420	892	370	850	185	640	90	760	152
AD50S2SS1FA AD50S2SS2FA AD71S2SS1FA AD71S2SS2FA	420	1212	370	1170	185	960	90	1080	152

Installation Procedure

- Each of the air sending duct and air return duct shall be fixed on the prefabricated panel of the floor by the iron bracket. The recommended distance between the edge of the air return duct and the wall is over 150mm.
- The gradient of the condensate water pipe shall keep over 1%.
- The condensate water pipe shall be thermal insulated.
- When installing the ceiling Concealed type indoor unit, the air return duct must be designed and installed as figure shown.

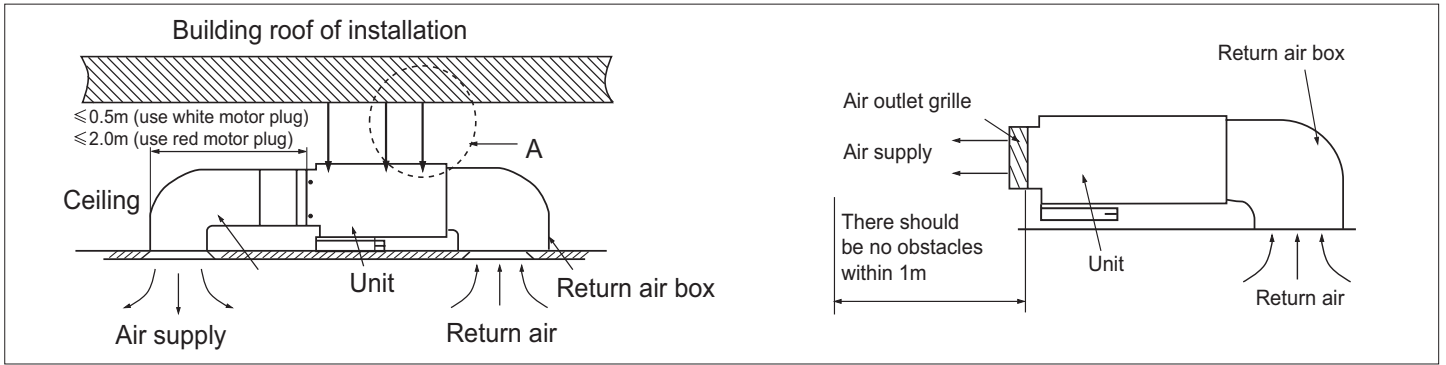

The sketch map of long duct

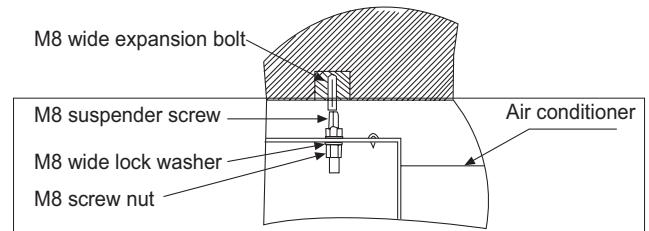
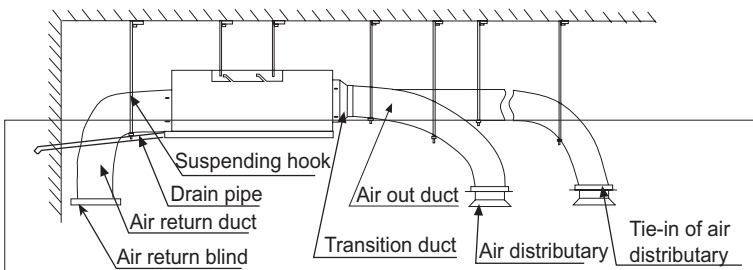

1. Installation of air sending duct

- This unit uses rounded duct, the diameter of the duct is 180mm.
- The rounded duct needs to add a transition duct to connect with the air-sending duct of indoor unit, then connect with respective separator. As Figure shown, all the fan speed of any of the separator's air outlet shall be adjusted approximately the same to meet the requirement for the room air conditioner.

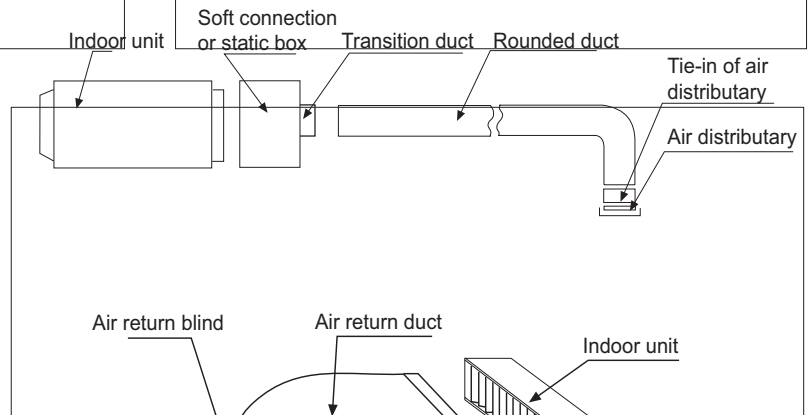

2. Installation of air return duct

- Use rivet to connect the air return duct on the air return inlet of the indoor unit, then connect the other end with the air return blind as Figure shown.

3. Thermal insulation of duct

- Air-sending duct and air return duct shall be thermally insulated. First stick the gluey nail on the duct, then attach the heat preservation cotton with a layer of tinfoil paper and use the gluey nail cap to fix. Finally use the tinfoil adhesive tape to seal the connected part. As Figure shown.

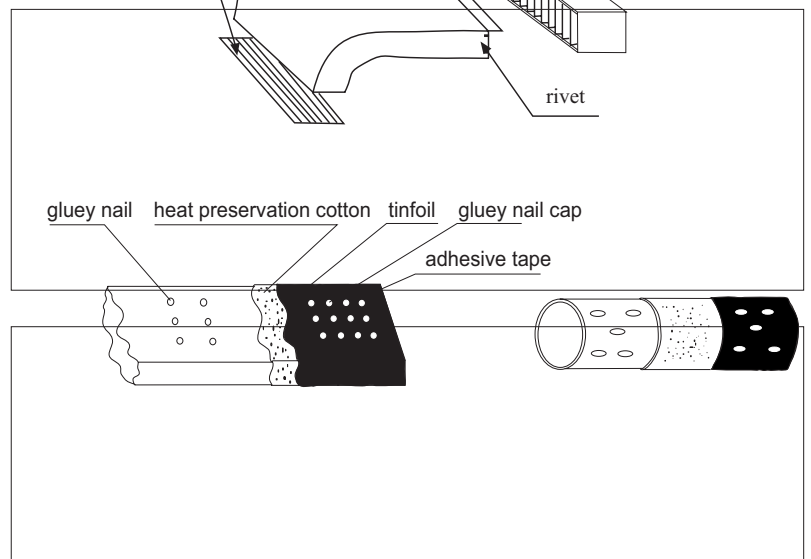

Installing the suspension screw

Use M8 or M10 suspension screws (4, prepared in the field) (when the suspension screw height exceeds 0.9m, M10 size is the only choice). These screws shall be installed as follows with space adapting to air conditioner overall dimensions according to the original building structures.

Wooden structure

A square wood shall be supported by the beams and then set the suspension screws.

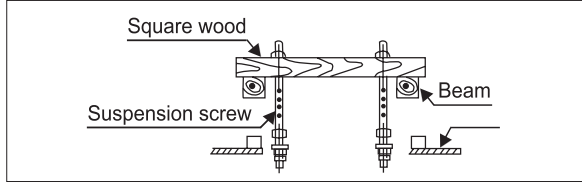

New concrete slab

To set with embedded parts, foundation bolts etc.

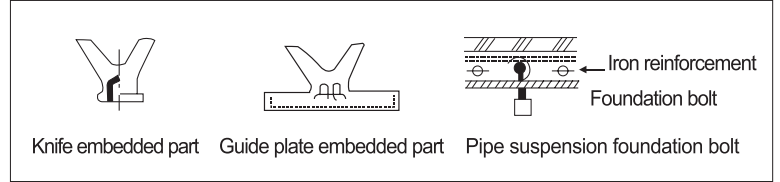

Original concrete slab

Use hole hinge, hole plunger or hole bolt.

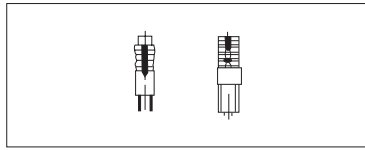

Steel reinforcement structure

Use steel angle or new support steel angle directly.

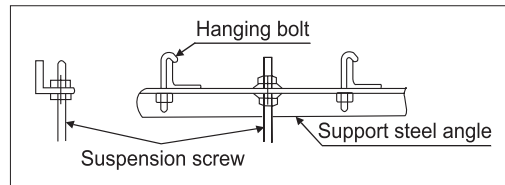

Hanging of the indoor unit

- Fasten the nut on the suspension screw and then hang the suspension screw in the T slot of the suspension part of the unit.
- Aided with a level meter, adjust level of the unit within 5mm

Installation Procedure

⚠ CAUTION

- In installation, if there is refrigerant gas leakage, please take ventilation measures immediately. The refrigerant gas will generate poisonous gas upon contacting fire.
- After installation, please verify that there is no refrigerant leakage. The leaked refrigerant gas will produce poisonous gas when meeting fire source such as heater and furnace etc.

Pipe material

Phosphorus deoxidized copper seamless pipe (TP2M) for air conditioner.

Allowable pipe length and drop

These parameters differ according to the outdoor unit. See the instruction manual attached with the outdoor unit for details.

Supplementary refrigerant

The refrigerant supplementation shall be as specified in the installation instructions attached with the outdoor unit. The adding procedure shall be aided with a measuring meter for a specified amount of supplemented refrigerant.

Note:

Overfilling or underfilling of refrigerant will cause compressor fault. The amount of the added refrigerant shall be as specified in the instructions.

Connection of refrigerant pipe

Conduct flared connection work to connect all refrigerant pipes.

- The connection of indoor unit pipes must use double spanners.
- The installing torque shall be as given in the following table.
- Wall thickness of connection pipe $\geq 0.8\text{mm}$

Creating vacuum

With a vacuum pump, create vacuum from the stop valve of the outdoor unit. Emptying with refrigerant sealed in the outdoor unit is absolutely forbidden.

Pipe size (unit :mm)

Model	Gas side	Liquid side
AD25S2SS1FA AD35S2SS1FA AD25S2SS2FA AD35S2SS2FA	$\varnothing 9.52$	$\varnothing 6.35$
AD50S2SS1FA AD50S2SS2FA	$\varnothing 12.7$	$\varnothing 6.35$
AD71S2SS1FA AD71S2SS2FA	$\varnothing 15.88$	$\varnothing 9.52$

Connecting pipe O.D.(mm)	Installing torque (N-m)
$\varnothing 6.35$	11.8 (1.2kgf-m)
$\varnothing 9.52$	24.5 (2.5 kgf-m)
$\varnothing 12.7$	49.0 (5.0 kgf-m)
$\varnothing 15.88$	78.4 (8.0 kgf-m)

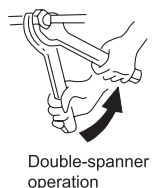

Open all valves

Open all the valves on the outdoor unit.

Gas leakage detection

Check with a leakage detector or soap water if there is gas leakage at the pipe connections and bonnets.

Insulation treatment

Conduct insulation treatment on both the gas side and liquid side of pipes respectively. During cooling operation, both the liquid and gas sides are cold and thus shall be insulated so as to avoid dew generation.

- The insulating material at gas side shall be resistant to a temperature above 120°C
- The indoor unit pipe connection part shall be insulated.

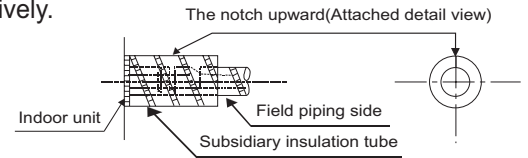

Installation Procedure

⚠ CAUTION

In order to drain water normally, the drain pipe shall be processed as specified in the installation manual and shall be thermal insulated to avoid dew generation. Improper hose connection may cause indoor water leakage.

Requirements

- The indoor drain pipe shall be thermal insulated.
- The connection part between the drain pipe and the indoor unit shall be insulated so as to prevent dew generation.
- The drain pipe shall be slant downwards (greater than 1/100). The middle part shall not be of S type elbow, otherwise abnormal sound will be produced.
- The horizontal length of the drain pipe shall be less than 20 m. In case of long pipe, supports shall be provided every 1.5 – 2m to prevent wavy form.
- Central piping shall be laid out according to the right figure.
- Take care not to apply external force onto the drain pipe connection part.
- For unit with water pump drain pipe use hard PVC general purpose pipe VP which can be purchased locally. When connecting, insert a PVC pipe end securely into the drain socket before tightening securely using the attached drain hose and clamp. Adhesive must not be used for connection of the drain socket and drain hose (accessory).

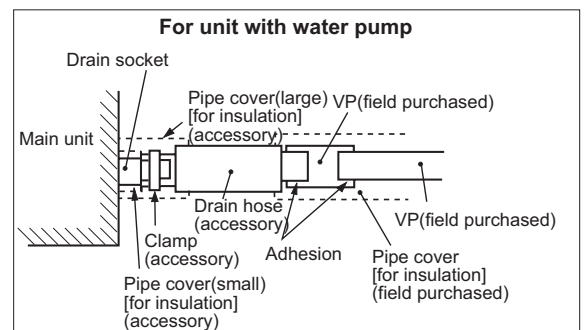
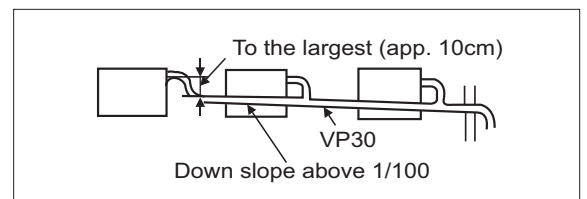
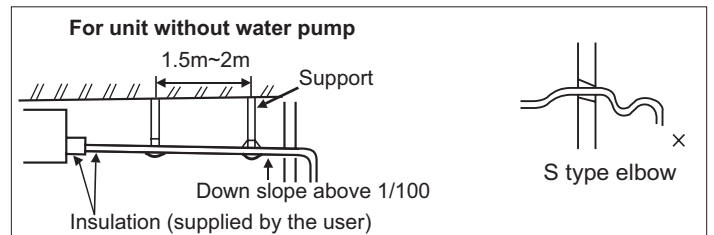

Pipe and insulation material

Pipe	Rigid PVC pipe VP20 mm (internal diameter)
Insulation	Foamed PE with thickness above 7 mm

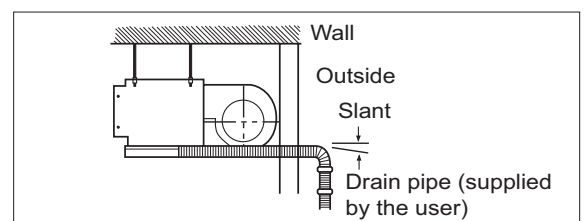

Hose

Drain pipe size: (3/4") PVC pipe

The hose is used for adjusting the off-center and angle of the rigid PVC pipe.

- Directly stretch the hose to install without making any deformation.
- The soft end of the hose must be fastened with a hose clamp.
- Please apply the hose on horizontal part Insulation treatment.
- Wrap the hose and its clamp up to the indoor unit without any clearance with insulating material, as shown in the figure.

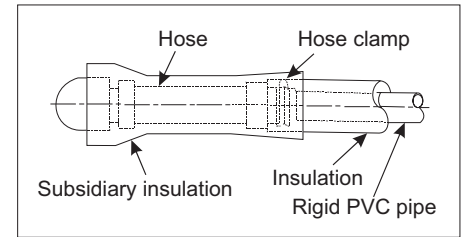

Drain confirmation

During trial run, check that there is no leakage at the pipe connection part during water draining even in winter.

⚠ WARNING

DANGER OF BODILY INJURY OR DEATH

TURN OFF ELECTRIC POWER AT CIRCUIT BREAKER OR POWER SOURCE BEFORE MAKING ANY ELECTRIC CONNECTIONS. GROUND CONNECTIONS MUST BE COMPLETED BEFORE MAKING LINE VOLTAGE CONNECTIONS.

Precautions for Electrical wiring

- Electrical wiring work should be conducted only by authorized personnel.
- Do not connect more than three wires to the terminal block. Always use round type crimped terminal lugs with insulated grip on the ends of the wires.
- Use copper conductor only.

Wiring connection

Make wiring to supply power to the outdoor unit, so that the power for the indoor unit is supplied by terminals.

The specification of power cable is HO5RN-F3G 4.0mm².

The specification of cable between indoor unit to outdoor unit is HO5RN-F4G 2.5mm².

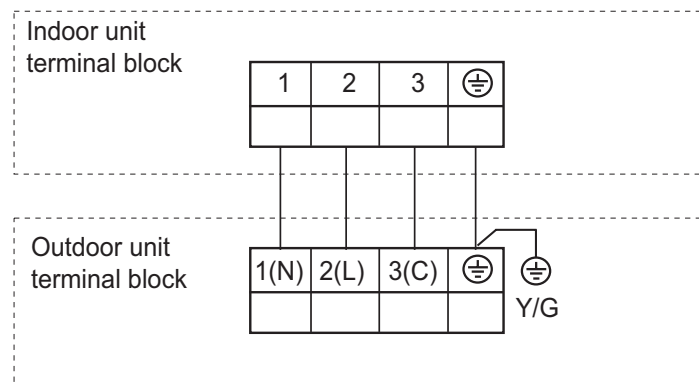

Cautions

- The installation of pipe-work shall be kept to a minimum.
- Pipe-work shall be protected from physical damage and shall not be installed in an unventilated space, if that space is smaller than Amin(2m²).
 - Compliance with national gas regulations shall be observed.
 - Mechanical connections shall be accessible for maintenance purposes.
- The minimum floor area of the room: 2 m².
 - The maximum refrigerant charge amount: 1.7 kg.
 - Information for handling, installation, cleaning, servicing and disposal of refrigerant.
 - Warning: Keep any required ventilation openings clear of obstruction.
 - Notice: Servicing shall be performed only as recommended by the manufacturer.

Unventilated areas

- Warning: The appliance shall be stored in a well-ventilated area where the room size corresponds to the room area as specified.
- Warning: The appliance shall be stored in a room without continuously operating open flames (e.g. an operating gas appliance) and ignition sources (e.g. an operating electric heater).

Qualification of workers

- Specific information about the required qualification of the working personnel for maintenance, service and repair operations.
 - Warning: Every working procedure that affects safety means shall only be carried out by competent persons.
- Examples for such working procedures are:
- breaking into the refrigerating circuit.
 - opening of sealed components
 - opening of ventilated enclosures.

Information on servicing

- Prior to beginning work on systems, safety checks are necessary to ensure that the risk of ignition is minimized.
- Work shall be undertaken under a controlled procedure so as to minimize the risk of flammable gas or vapor being present while the work is being performed.
- Work in confined spaces shall be avoided. The area around the workspace shall be sectioned off. Ensure that the conditions within the area have been made safe by control of flammable material.

Checking for presence of refrigerant

- The area shall be checked with an appropriate refrigerant detector prior to and during work. The leak detection equipment should be suitable for use with all applicable refrigerants, i.e. non-sparking, adequately sealed or intrinsically safe.

Presence of fire extinguisher

- If any hot work is to be conducted, appropriate fire extinguishing equipment shall be available to hand. Have a dry powder or CO₂ fire extinguisher adjacent to the charging area.

No ignition sources

- All possible ignition sources, including cigarette smoking, should be kept sufficiently far away from the site of installation, repairing, removing and disposal. Prior to work taking place, the area around the equipment is to be surveyed to make sure that there are no flammable hazards or ignition risks. "No Smoking" signs shall be displayed.

Ventilated area

- Ensure that the area is in the open or that it is adequately ventilated before breaking into the system or conducting any hot work. A degree of ventilation shall continue during the period that the work is carried out. The ventilation should safely disperse any released refrigerant and preferably expel it externally into the atmosphere.

Checks to the refrigeration equipment

- Where electrical components are being changed, they shall be fit for the purpose and to the correct specification. At all times the manufacturer's maintenance and service guidelines shall be followed. If in doubt, consult the manufacturer's technical department for assistance.

The following checks shall be applied to installations

- The charge size is in accordance with the room size within which the refrigerant containing parts are installed;
- The ventilation machinery and outlets are operating adequately and are not obstructed;
- If an indirect refrigerating circuit is being used, the secondary circuit shall be checked for the presence of refrigerant;
- Marking to the equipment continues to be visible and legible. Markings and signs that are illegible shall be corrected;
- Refrigeration pipe or components are installed in a position where they are unlikely to be exposed to any substance which may corrode refrigerant containing components, unless the components are constructed of materials which are inherently resistant to being corroded or are suitably protected against being so corroded.

Cautions

Checks to electrical devices

- Repair and maintenance to electrical components shall include initial safety checks and component inspection procedures. If a fault exists that could compromise safety, then no electrical supply shall be connected to the circuit until it is satisfactorily dealt with. If the fault cannot be corrected immediately but it is necessary to continue operation, an adequate temporary solution shall be used. This shall be reported to the owner of the equipment so all parties are advised.

- Initial safety checks shall include:
 - that capacitors are discharged: this shall be done in a safe manner to avoid possibility of sparking;
 - that no live electrical components and wiring are exposed while charging, recovering or purging the system;
 - that there is continuity of earth bonding.

Repairs to sealed components

- During repairs to sealed components, all electrical supplies shall be disconnected prior to any removal of sealed covers, etc. If it is absolutely necessary to have an electrical supply to equipment during servicing, then a permanently operating form of leak detection shall be located at the most critical point to warn of a potentially hazardous situation.

- Ensure that by working on electrical components, the casing is not altered in such a way that the level of protection is affected, including damage to cables, excessive number of connections, terminals not made to original specification, damage to seals, incorrect fitting of glands, etc.

- Ensure that the apparatus is mounted securely.

- Ensure that seals or sealing materials have not degraded to the point that they no longer serve the purpose of preventing the ingress of flammable atmospheres. Replacement parts shall be in accordance with the manufacturer's specifications.

Repair to intrinsically safe components

- Do not apply any permanent inductive or capacitance loads to the circuit without ensuring that this will not exceed the permissible voltage and current permitted for the equipment in use.

- Intrinsically safe components are the only types that can be worked on while live in the presence of a flammable atmosphere.

- Replace components only with parts specified by the manufacturer. Other parts may result in the ignition of refrigerant in the atmosphere from a leak.

Cabling

- Check that cabling will not be subject to wear, corrosion, excessive pressure, vibration, sharp edges or any other adverse environmental effects. The check shall also take into account the effects of aging or continual vibration from sources such as compressors or fans.

Detection of flammable refrigerants

Removal and evacuation

- The refrigerant charge shall be recovered into the correct recovery cylinders and the system shall be "flushed" with OFN to render the unit safe. This process may need to be repeated several times.

- Compressed air or oxygen shall not be used for purging refrigerant systems.

- Flushing shall be achieved by breaking the vacuum in the system with OFN and continuing to fill until the working pressure is achieved, then venting to atmosphere, and finally pulling down to a vacuum. This process shall be repeated until no refrigerant is within the system. When the final OFN charge is used, the system shall be vented down to atmospheric pressure to enable work to take place.

- The vacuum pump is not close to any ignition sources and that ventilation is available.

Charging procedures

- Ensure that contamination of different refrigerants does not occur when using charging equipment. Hoses or lines shall be as short as possible to minimise the amount of refrigerant contained in them.

- Cylinders shall be kept upright.

- Ensure that the refrigeration system is earthed prior to charging the system with refrigerant.

- Label the system when charging is complete (if not already).

- Extreme care shall be taken not to overfill the refrigeration system.

- Prior to recharging the system, it shall be pressure-tested with the appropriate purging gas. The system shall be leak-tested on completion of charging but prior to commissioning. A follow up leak test shall be carried out prior to leaving the site.

Decommissioning

- Before carrying out this procedure, it is essential that the technician is completely familiar with the equipment and all its detail.

- Prior to the task being carried out, an oil and refrigerant sample shall be taken in case analysis is required prior to re-use of reclaimed refrigerant.

- Electrical power must be available before the task is commenced.

Cautions

- Become familiar with the equipment and its operation.
 - Isolate system electrically.
 - Before attempting the procedure, ensure that:
 - mechanical handling equipment is available, if required, for handling refrigerant cylinders;
 - all personal protective equipment is available and being used correctly;
 - the recovery process is supervised at all times by a competent person;
 - recovery equipment and cylinders conform to the appropriate standards.
 - Pump down refrigerant system, if possible.
 - If a vacuum is not possible, make a manifold so that refrigerant can be removed from various parts of the system.
 - Make sure that cylinder is situated on the scales before recovery takes place.
 - Start the recovery machine and operate in accordance with manufacturer's instructions.
 - Do not overfill cylinders. (No more than 80 % volume liquid charge).
 - Do not exceed the maximum working pressure of the cylinder, even temporarily.
 - When the cylinders have been filled correctly and the process completed, make sure that the cylinders and the equipment are removed from site promptly and all isolation valves on the equipment are closed off.
 - Recovered refrigerant shall not be charged into another refrigeration system unless it has been cleaned and checked.

Labelling

- Equipment shall be labelled stating that it has been de-commissioned and emptied of refrigerant. The label shall be dated and signed.
 - Ensure that there are labels on the equipment stating the equipment contains flammable refrigerant.

Recovery

- When transferring refrigerant into cylinders, ensure that only appropriate refrigerant recovery cylinders are employed.
 - Ensure that the correct number of cylinders for holding the total system charge are available. All cylinders to be used are designated for the recovered refrigerant and labelled for that refrigerant (i.e. special cylinders for the recovery of refrigerant).
 - Cylinders shall be complete with pressure-relief valve and associated shut-off valves in good working order. Empty recovery cylinders are evacuated and, if possible, cooled before recovery occurs.
 - The recovery equipment shall be in good working order with a set of instructions concerning the equipment that is at hand and shall be suitable for the recovery of all appropriate refrigerants.
 - A set of calibrated weighing scales shall be available and in good working order. Hoses shall be complete with leak-free disconnect couplings and in good condition. Before using the recovery machine, check that it is in satisfactory working order, has been properly maintained and that any associated electrical components are sealed to prevent ignition in the event of a refrigerant release.
 - The recovered refrigerant shall be returned to the refrigerant supplier in the correct recovery cylinder, and the relevant waste transfer note arranged.
 - Do not mix refrigerants in recovery units and especially not in cylinders.
- If compressors or compressor oils are to be removed, ensure that they have been evacuated to an acceptable level to make certain that flammable refrigerant does not remain within the lubricant.
- The evacuation process shall be carried out prior to returning the compressor to the suppliers.
 - Only electric heating to the compressor body shall be employed to accelerate this process.



Haier

Address: Haier Industrial Park, Qianwangang Road, Eco-Tech Development Zone, Qingdao 266555, Shandong, P.R.C.

Contacts: TEL +86-532-88936943; FAX +86-532-8893-6999

Website: www.haier-ac.pl